

KE850

CE 0168

www.pradaphonebylg.com

P/N : MMBB022206 (1.1) 

KE850/USER GUIDE

PRADA / LG ELECTRONICS INC.

PRADA

ENGLISH

Please read this manual carefully before
operating your mobile phone. Retain it
for future reference.

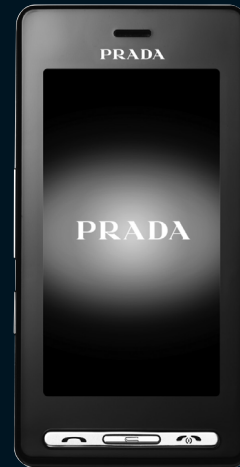

KE850 | USER GUIDE

Some of contents in this manual may differ from your phone depending on the software version of the phone or your service provider.



Disposal of your old appliance

1. When this crossed-out wheeled bin symbol is attached to a product it means the product is covered by the European Directive 2002/96/EC.
2. All electrical and electronic products should be disposed of separately from the municipal waste stream via designated collection facilities appointed by the government or the local authorities.
3. The correct disposal of your old appliance will help prevent potential negative consequences for the environment and human health.
4. For more detailed information about disposal of your old appliance, please contact your city office, waste disposal service or the shop where you purchased the product.



CONTENTS

5 INTRODUCTION

7 GUIDELINES FOR SAFE AND EFFICIENT USE

10 KE850 FEATURES

- 10 Part of the phone
- 13 Display information
- 14 On-Screen Icons

15 INSTALLATION

- 15 Installing the SIM card and the handset battery
- 17 Charging the Battery
- 17 Disconnecting the charger
- 18 Memory Card

19 GENERAL FUNCTIONS

- 19 Making a Call
- 19 Adjusting the Volume
- 19 Answering a Call
- 20 Entering Text

22 SELECTING FUNCTIONS AND OPTIONS

23 IN-CALL MENU

- 23 During a Call
- 24 Conference Calls

26 MENU TREE

29 DIALLING

30 CONTACTS

- 30 Search
- 30 New contact
- 30 Speed dials
- 31 Groups
- 31 Settings
- 31 Information

32 CALL HISTORY

- 32 All calls
- 32 Missed calls
- 32 Dialed calls
- 32 Received calls
- 32 Call charges
- 33 Data information

34 MESSAGE

- 34 New text message
- 34 New multimedia message
- 35 New email message
- 36 Inbox
- 36 Email box
- 36 Drafts
- 37 Outbox
- 37 Sent
- 37 Voice mail
- 37 Info service

38	Templates	51 MP3 PLAYER	57 SETTINGS
38	Settings	51 All songs	57 DISPLAY
40 BROWSER		52 Settings	57 Wallpaper
40	Home	53 FM RADIO	57 Backlight
40	Bookmarks	54 GAMES & APPS	57 Clock
40	Go to URL	54 Default games	57 Brightness
40	Settings	54 Downloaded	57 Theme
42 MULTIMEDIA		54 Information	57 Network name
42 MY STUFF		54 Settings	58 PROFILE
42	Images	55 TOOLS	58 General
43	Sounds	55 ALARM CLOCK	58 Silent
44	Videos	55 CALCULATOR	58 Vibrate only
46	Documents	55 WORLD CLOCK	58 Outdoor
46	Others	55 UNIT CONVERTER	58 Headset
47 CAMERA		56 CALENDAR	59 SETTINGS
49 CAMCORDER		56 MEMO	59 Date & Time
50 VOICE RECORDER			59 Power saving
			59 Languages

- 59 Call
- 60 Security
- 62 Connectivity
- 62 Flight mode
- 63 Reset setting
- 63 Memory status

64 BLUETOOTH

- 64 Bluetooth on/off
- 64 Device list
- 64 Bluetooth settings
- 64 Supported services

65 SIM SERVICE

66 ACCESSORIES

67 NETWORK SERVICE

68 TROUBLESHOOTING

70 TECHNICAL DATA

Congratulations on your purchase of the advanced and compact Prada phone by LG, designed to operate with the latest digital mobile communication technology.



This user's guide contains important information on the use and operation of this phone. Please read all the information carefully for optimal performance and to prevent any damage to or misuse of the phone. Any changes or modifications not expressly approved in this user's guide could void your warranty for this equipment.

Please read these simple guidelines. Not following these guidelines may be dangerous or illegal. Further detailed information is given in this manual.

WARNING

- Mobile Phones must be switched off at all times in an aircraft.
- Do not hold the phone in your hand while driving.
- Do not use your phone near petrol stations, fuel depots, chemical plants or blasting operations.
- For your safety, use **ONLY** specified **ORIGINAL** batteries and chargers.
- Do not handle the phone with wet hands while it is being charged. It may cause an electric shock or seriously damage your phone.
- Keep the phone in a safe place out of small children's reach. It includes small parts which if detached may cause a choking hazard.

CAUTION

- Switch off the phone in any area where required by special regulations. For example, do not use your phone in hospitals or it may affect sensitive medical equipment.
- Emergency calls may not be available under all mobile networks. Therefore, you should never depend solely on the phone for emergency calls.
- Only use **ORIGINAL** accessories to avoid damage to your phone.
- All radio transmitters carry risks of interference with electronics in close proximity. Minor interference may affect TVs, radios, PCs, etc.
- Batteries should be disposed of in accordance with relevant legislation.
- Do not dismantle the phone or battery.

EXPOSURE TO RADIO FREQUENCY ENERGY

Radio wave exposure and Specific Absorption Rate (SAR) information

This mobile phone model KE850 has been designed to comply with applicable safety requirement for exposure to radio waves. This requirement is based on scientific guidelines that include safety margins designed to assure this safety of all persons, regardless of age and health.

- The radio wave exposure guidelines employ a unit of measurement known as the Specific Absorption Rate, or SAR. Tests for SAR are conducted using standardized method with the phone transmitting at its highest certified power level in all used frequency bands.
- While there may be differences between the SAR levels of various LG phone models, they are all designed to meet the relevant guidelines for exposure to radio waves.
- The SAR limit recommended by the international Commission on Non-Ionizing Radiation Protection (ICNIRP), which is 2W/kg averaged over ten (10) gram of tissue.
- The highest SAR value for this model phone tested by DASY4 for use at the ear is 0.838 W/kg (10g).
- SAR data information for residents in countries/regions that have adopted the SAR limit recommended by the Institute of Electrical and Electronics Engineers (IEEE), which is 1.6 W/kg averaged over one (1) gram of tissue.

PRODUCT CARE AND MAINTENANCE

> WARNING:

Use only batteries, chargers and accessories approved for use with this particular phone model. The use of any other types may invalidate any approval or warranty applying to the phone, and may be dangerous.

- Do not disassemble this unit. Take it to a qualified service technician when repair work is required.
- Keep away from electrical appliances such as TVs, radios, and personal computers.
- The unit should be kept away from heat sources such as radiators or cookers.
- Do not drop.
- Do not subject this unit to mechanical vibration or shock.
- The coating of the phone may be damaged if covered with wrap or vinyl wrapper.
- Use dry cloth to clean the exterior of the unit. (Do not use solvent such as benzene, thinner or alcohol.)
- Do not subject this unit to excessive smoke or dust.
- Do not keep the phone next to credit cards or transport tickets; it can affect the information on the magnetic strips.
- Do not tap the screen with a sharp object; otherwise, it may damage the phone.
- Do not expose the phone to liquid or moisture.
- Use the accessories like an earphone cautiously. Do not touch the antenna unnecessarily.

EFFICIENT PHONE OPERATION

ELECTRONICS DEVICES

All mobile phones may get interference, which could affect performance.

- Do not use your mobile phone near medical equipment without requesting permission. Avoid placing the phone over pacemakers, i.e. in your breast pocket.
- Some hearing aids might be disturbed by mobile phones.
- Minor interference may affect TVs, radios, PCs, etc.

ROAD SAFETY

Check the laws and regulations on the use of mobile phones in the areas when you drive.

- Do not use a hand-held phone while driving.
- Give full attention to driving.
- Use a hands-free kit, if available.
- Pull off the road and park before making or answering a call if driving conditions so require.
- RF energy may affect some electronic systems in your vehicle such as car stereos and safety equipment.
- When your vehicle is equipped with an air bag, do not obstruct with installed or portable wireless equipment. It can fail or cause serious injury due to improper performance.

BLASTING AREA

Do not use the phone where blasting is in progress. Observe restrictions, and follow any regulations or rules.

POTENTIALLY EXPLOSIVE ATMOSPHERES

- Do not use the phone at a refueling point. Don't use near fuel or chemicals.
- Do not transport or store flammable gas, liquid, or explosives in the compartment of your vehicle which contains your mobile phone and accessories.

IN AIRCRAFT

Wireless devices can cause interference in aircraft.

- Turn off your mobile phone before boarding any aircraft.
- Do not use it on the ground without crew permission.

CHILDREN

Keep the phone in a safe place out of small children's reach. It includes small parts which if detached may cause a choking hazard.

EMERGENCY CALLS

Emergency calls may not be available under all mobile networks. Therefore, you should never depend solely on the phone for emergency calls. Check with your local service provider.

BATTERY INFORMATION AND CARE

- You do not need to completely discharge the battery before recharging. Unlike other battery systems, there is no memory effect that could compromise the battery's performance.
- Use only LG batteries and chargers. LG chargers are designed to maximize the battery life.
- Do not disassemble or short-circuit the battery pack.
- Keep the metal contacts of the battery pack clean.
- Replace the battery when it no longer provides acceptable performance. The battery pack may be recharged hundreds of times until it needs replacing.
- Recharge the battery if it has not been used for a long time to maximize usability.
- Do not expose the battery charger to direct sunlight or use it in high humidity, such as the bathroom.
- Do not leave the battery in hot or cold places, this may deteriorate the battery performance.
- There is risk of explosion if the battery is replaced by an incorrect type.
- Dispose of used batteries according to the manufacturer's instructions. Please recycle when possible. Do not dispose as household waste.

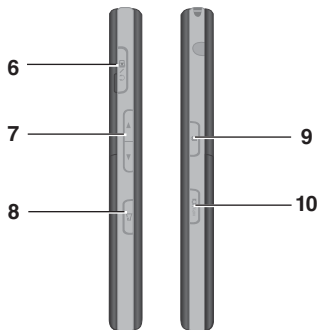
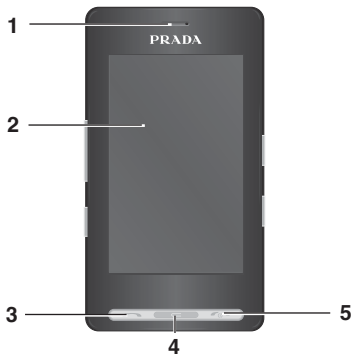

PART OF THE PHONE

1. EARPIECE

2. MAIN LCD

- **Top:** Signal strength, battery level and various function
- **Bottom:** Menu/Dialling/Message/Phonebook indications

3. SEND KEY

- **Dials a phone number and answers incoming calls.**

4. CLEAR KEY

- **Deletes a character with each press.**
- **Uses this key to go back to a previous screen.**

5. END/POWER KEY

- **Ends or rejects a call.**
- **Turns the phone on/off.**

6. CHARGER/CABLE/HANDSFREE CONNECTOR

7. SIDE KEYS

- **When the screen is idle:** Volume of key tone
- **In menu:** scroll up & down
- **During a call:** volume of the earpiece

8. PROFILE KEY

- **Long press activates/deactivates vibrate mode.**
- **Enters the profile menu directly by pressing this key shortly.**
- **Long press activates Unlock mode in key lock.**

9. KEYPAD LOCK/UNLOCK KEY

10. MP3/CAMERA KEY

- **Press this key shortly to enter MP3 menu.**
- **Press and hold this key to activate camera.**

REAR VIEW

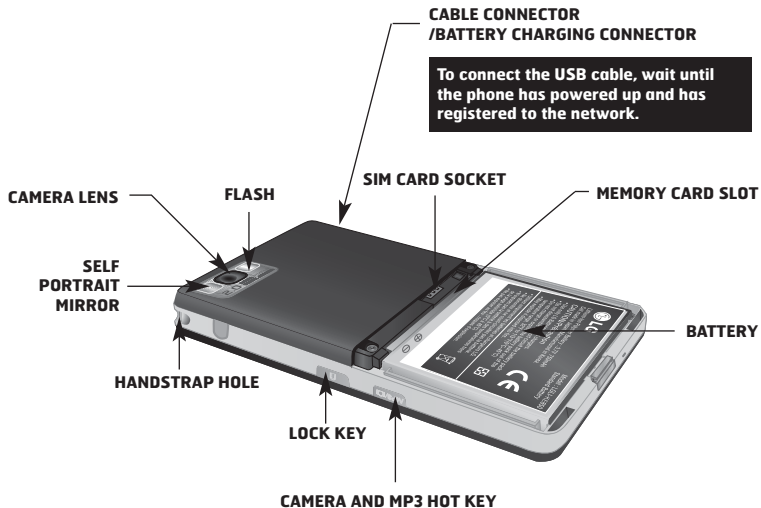

- This product's keys on the LCD screen are touch keys.
- Be sure to read "Cautions for Touch Keys" before using this product.

CAUTIONS FOR TOUCH KEYS

1. Make sure your hands are clean and dry.
 - Remove all moisture from the surface of your hands or the touch keys in a humid environment.







2. You do not need to press hard on the touch keys to make them work.
Do not subject the product to severe impact, as this may damage the touch key sensors.
3. Use the tip of your finger to press exactly on the touch key you want, being careful not to touch the keys for other functions.
4. When both the home screen and touch key lights are off, pressing a touch key will not turn on the home screen light. Press **Power** and the home screen light will turn back on (touch keys do not work when the touch key lights are off).
5. Touch keys may not work normally if a mobile phone case or plastic cover is covering them. Also, touch keys may not work if you are wearing gloves.
6. Keep metal and other conductive materials away from the surface of the touch keys, as contact with them may result in an error.
7. This phone does not allow to use a pen or a stylus to select menu. If you use a pen or a stylus, the menus cannot be activated properly. Use the phone by only finger.
8. Touch key cannot be activated properly in hot and humid environment.

DISPLAY INFORMATION























If you tap the wallpaper "Analogue clock" once, you can set the alarm. Analogue clock is set as a default.

ICON	DESCRIPTION
	Used to enter menu directly.
	Used to make a call or send text/multimedia message.
	Used to send the text/multimedia message and to view the messages in the inbox. You can activate various functions related to messages.
	Used to access the phonebook list.

The screen displays several icons. These are described below.

ON-SCREEN ICONS

ICON/INDICATOR	DESCRIPTION
	Tells you the strength of the network signal.
	Indicates that you are using GPRS.
	Indicates that you are using EDGE service.
	Shows that you are out of service area.
	Shows that you are using a roaming service.
	The alarm has been set and is on.
 (Empty)	Tells you the status of the battery.
 (Full)	
	Indicates that you have received a text message.
	Indicates that you have received a voice message.
	Indicates that the message box is full.

ICON/INDICATOR	DESCRIPTION
	Vibrate only menu in profile.
	General menu in profile.
	Outdoor menu in profile.
	Silent menu in profile.
	Headset menu in profile.
	Indicates that you have diverted a call.
	Indicates that the phone is accessing WAP.
	Indicates that you have activated flight mode.
	Indicates that you have activated Bluetooth.

The quality of the conversation may change depending on network coverage. When the signal strength is below 2 bars, you may experience muting, call drop and poor audio. Please take the network bars as an indicator for your calls. When there are no bars, that means that there is no network coverage: in this case, you won't be able to access the network for any service (call, messages and so on).

INSTALLING THE SIM CARD AND THE HANDSET BATTERY

Make sure the power is off before you remove the battery.

1. REMOVE THE BATTERY COVER.

Press the battery release latch and lift the battery cover from the bottom of the phone.



2. REMOVE THE BATTERY.

Hold the top edge of the battery and lift the battery from the battery compartment.



Removing the battery from the phone when the power is on may cause the phone to malfunction.

3. INSTALL THE SIM CARD.

Slide the SIM card into the SIM card holder. Make sure that the SIM card is inserted properly and that the gold contact area on the card is facing downwards. To remove the SIM card, press down lightly and pull it in the reverse direction.

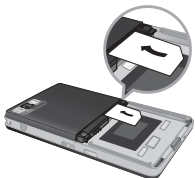

To insert the SIM card



To remove the SIM card

The metal contact of the SIM card can be easily damaged by scratches. Pay special attention to the SIM card while handling. Follow the instructions supplied with the SIM card.

4. INSTALL THE BATTERY.

Insert the bottom of the battery first into the bottom edge of the battery compartment. Ensure the battery contacts align with the terminals on the phone. Push down the top of the battery until it snaps into space. Do not force the battery.



5. REPLACE THE BATTERY COVER.

Lay the battery cover in place on the phone and press it down until the latch clicks.



CHARGING THE BATTERY

Before connecting the charger to the phone you must first check the battery is installed.



1. Ensure the battery is fully charged before using the phone.
2. With the arrow on the plug facing down, push the plug on the charger into the socket on the side of the phone.
3. Connect the other end of the charger to the main socket. Use only the charger included in the box with the phone.
4. The moving bars of the battery icon will stop after charging is complete.

- Do not force the connector as this may damage the phone and/or the charger.
- If you use the charger out of your own country, use an attachment plug adaptor for the proper configuration.
- Do not remove your battery or the SIM card while charging.
- There is risk of explosion if battery is replaced by an incorrect type. Dispose of used batteries according to the maker's instructions.

- Unplug the charger from the mains and phone during lightning storms to avoid electric shock or fire.
- Make sure that no sharp-edged items such as animal teeth or nails come into contact with the battery. There is a risk of this causing a fire.

DISCONNECTING THE CHARGER

Disconnect the travel adapter from the phone as shown in the diagram. Make sure you pull by the plug, not the cord.



MEMORY CARD

Slide the memory card into the slot until the memory card is fully inserted into the slot, as shown in the figure below:

INSTALLING THE MEMORY CARD

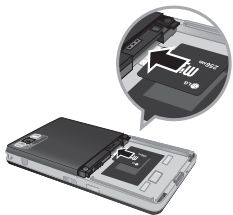

Slide the memory card in with the metal contacts facing down.

REMOVING THE MEMORY CARD

1. Push in memory card with the tip of your finger into the slot which will activate the eject mechanism.
2. Carefully pull the memory card out of slot.



Remove the memory card

- The memory card must be removed or inserted only when necessary as its removal/insertion may lead to failure.
- When inserting an external memory card, remove and insert it again if its icon appears red. (If the icon remains red after re-insertion, the memory card may likely be damaged, so replace it with another one.)
- Removal of an external memory card or turning the mobile phone off while using the card (Store, Copy, Remove, Initialise, Play, etc.) may clear or initialise any stored file, which in turn may lead to severe damage on the card or malfunction of the phone.
- It is recommended the card be initialised within the mobile phone. The memory card includes some system space for any external memory file so some capacity may survive the initialisation of the memory card.
- It is always advised to make a backup of any data stored on your memory card.
- A few memory cards cannot be compatible with a phone, so please contact manufacture for details.

MAKING A CALL

1. Make sure your phone is powered on.
2. In standby mode, tap icon.
3. Enter a phone number including the area code.
To edit a number on the display screen, simply press the key to erase one digit at a time.
◦ If you press key or tap , you can go back to previous menu.
4. Press the key or tap to call.
5. When you want to finish, press the key.

MAKING AN INTERNATIONAL CALL

1. Tap and hold the key for the international prefix. The '+' character can be replaced with the international access code.
2. Enter the country code, area code, and the phone number.
3. Press the key or tap to call.

ENDING A CALL

When you have finished a call, press the key.

MAKING A CALL FROM THE CONTACT LIST

You can store names and phone numbers dialed frequently in the SIM card as well as the phone memory known as the Contact list. You can dial a number by simply looking up a name in the contact list. For more details on the Contacts feature, please refer to page 30.

ADJUSTING THE VOLUME

Use the up/down keys on the side of the phone to adjust the volume during a call.

ANSWERING A CALL

When you receive a call, the phone rings and the animated phone icon appears on the screen. If the caller can be identified, the caller's phone number (or name/picture if stored in your Contact list) is displayed.

1. Press the key or the left soft key to answer an incoming call.
2. End the call by pressing the key.

You can answer a call while using the address book or other menu features. In case the phone is connected to the PC via USB cable, incoming calls will be rejected, but after disconnecting the phone from the PC you can see a Missed call window.

LOCK TOUCH SCREEN AND KEYPAD

Keypad Lock Mode can be activated by pressing the key.

SIGNAL STRENGTH

If you are inside a building, being near a window may give you better reception. You can see the strength of your signal by the signal indicator () on your phone's display screen.

ENTERING TEXT

You can enter alphanumeric characters by using the keypad on the touch screen. For example, storing names in the phonebook, writing a message, and scheduling events in the calendar all require entering text. The following text input methods are available in the phone.

Some fields may allow only one text input mode (e.g. telephone number in address book fields).

T9 MODE

This mode allows you to enter words with only one keystroke per letter. Each key on the keypad has more than one letter. The T9 mode automatically compares your keystrokes with an internal linguistic dictionary to determine the correct word, thus requiring far fewer keystrokes than the traditional ABC mode. T9 is set to Off as default.

To enter T9 mode, tap , and then select T9 then T9 on.

ABC MODE

This mode allows you to enter letters by pressing the key labeled with the required letter once, twice, three or four times until the letter is displayed.

123 MODE (NUMBERS MODE)

Type numbers using one keystroke per number. To change to 123 mode in a text entry field, tap  key until 123 mode is displayed in the upper right corner of the display.

You can go back to previous letter mode by long press .

SYMBOLIC MODE

This mode allows you to enter special characters.

CHANGING THE TEXT INPUT MODE



1. When you are in a field that allows characters to be entered, you will notice the text input mode indicator in the upper right corner of the display.
2. If you want to change modes, tap  to step through the available modes.

You can go back to previous letter mode by long press .



USING THE T9 MODE

The T9 predictive text input mode allows you to enter words easily with a minimum number of key presses. As you press each key, the phone begins to display the characters that it thinks you are typing based on a built-in dictionary. As new letters are added, the word changes to reflect the most likely candidate from the dictionary.

You can select a different T9 language from the menu option . The default setting on the phone is T9 disable mode.

1. When you are in the T9 predictive text input mode, start entering a word by tapping keys  to .
- The word changes as letters are typed—ignore what's on the screen until the word is typed completely.



Example: Press     to type **Good**.

- If the desired word is missing from the word choices list, add it by using the ABC mode.
2. Enter the whole word before editing or deleting any key strokes.
 3. Complete each word with a space by pressing the  key.
- To delete letters, press . Press and hold down  to erase the letters continuously.

To exit the text input mode without saving your input, press . The phone returns to the idle screen.

USING THE ABC MODE

Use the  to  keys to enter your text.

1. Tap the key labelled with the required letter:
 - Once for the first letter.
 - Twice for the second letter, and so on.
2. To insert a space, tap the  key once. To delete letters, press the  key. Tap and hold down the  key to erase the letters continuously.

If you select Insert menu on writing the message, you can insert the symbol, image, sound, text template and contact point.

USING THE 123 (NUMBERS) MODE

The 123 Mode enables you to enter numbers in a text message (a telephone number, for example). Tap the keys corresponding to the required digits before manually switching back to the appropriate text entry mode.

You can also add numbers whilst remaining in letter modes by tapping and holding the desired key.

USING THE SYMBOL MODE



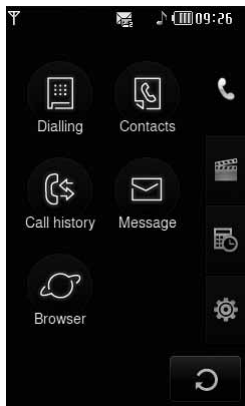

The Symbol Mode enables you to enter various symbols or special characters. To enter a symbol, press the  key.

The touch screen consists of the menus as follow:



The top menu icons of title can be different depending on the theme. (The default mode is Black theme.)

Title menu

ICON	DESCRIPTION
	Call menu
	Multimedia menu
	Tool menu
	Setting menu

Your phone provides a number of control functions that you can use during a call. To access these functions during a call, press the left soft key  [Options].

If you activate Key lock, you can select Mute key.

DURING A CALL

The menu displayed on the handset screen during a call is different than the default main menu displayed when in idle screen, and the options are described below.

SPEAKER PHONE

During call you can activate speaker phone by pressing the LOCK key and then pressing the  key.

MAKING A SECOND CALL (NETWORK DEPENDENT)

You can get a number you wish to dial from the phonebook to make a second call. During a call, if you press profile key, you can activate the dial pad.

SWITCHING BETWEEN TWO CALLS



To switch between two calls, press  key or the left soft key, and then select Swap call.

ANSWERING AN INCOMING CALL

To answer an incoming call when the handset is ringing, simply press the  key. The handset is also able to warn you of an incoming call while you are already on a call. A tone sounds in the earpiece, and the display will show that a second call is waiting.

This feature, known as Call waiting, is only available if your network supports it. If Call waiting is on, you can put the first call on hold and answer the second, by pressing the left soft key.

REJECTING AN INCOMING CALL

You can reject an incoming call without answering by simply pressing the  key. During a call, you can reject an incoming call by pressing the  key twice.

MUTING THE MICROPHONE

You can mute the microphone during a call by tapping the [Mute] key in the bottom right. The handset can be unmuted by tapping the [Unmute]. When the handset is muted, the caller cannot hear you, but you can still hear them.

DTMF TONES WHILE CALLING

To switch on DTMF tones while calling (e.g. to use the phone with an automatic switchboard) tap [Options] followed by Send DTMF – DTMF on. Select DTMF off to disable DTMF tones. DTMF tones are normally on.



The display and keypad backlights will turn off after a few seconds while in a call if no keys are pressed. To turn on the backlight press any key. DTMF is not sent when the backlight is off.

To activate the keypad in a call, press the  on the side.

CONFERENCE CALLS

The conference service provides you with the ability to have a simultaneous conversation with more than one caller, if your network service provider supports this feature. A conference call can only be set up when you have one active call and one call on hold, both calls having been answered. Once a conference call is set up, calls may be added, disconnected or separated (that is, removed from the conference call but still connected to you) by the person who set up the conference call. These options are all available from the In-Call menu. The maximum callers in a conference call are five. Once started, you are in control of the conference call, and only you can add calls to the conference call.

MAKING A SECOND CALL



You can make a second call while currently on a call. Enter the second number and press the  . When the second call is connected, the first call is automatically placed on hold. You can swap between calls, by pressing the  key.

To activate the keypad in a call, press the  on the side.

SETTING UP A CONFERENCE CALL

To set up a conference call, place one call on hold and while the active call is on, press the left soft key and then select the Join menu of Conference call.

ACTIVATE THE CONFERENCE CALL ON HOLD

To activate Hold on a conference call, press the  key. Alternatively press the left soft key [Options] and select Conference/Hold all calls. Other users on hold will stay connected. To return to conference call mode, tap  [Options] followed by Conference call.

ADDING CALLS TO THE CONFERENCE CALL

To add a call to an existing conference call, tap the left soft key, and then select the Join menu of Conference call.

PRIVATE CALL IN A CONFERENCE CALL

To have a private call with one caller from a conference call, display the number of the caller you wish to talk to on the screen, then tap the left soft key. Select the Private menu of Conference call to put all the other callers on hold.

ENDING A CONFERENCE CALL

A currently displayed caller from a conference call can be disconnected by pressing the  key.



This icon refers to the menus related to call, message and browser.

Dialling

Contacts

- 1 Search
- 2 New contact
- 3 Speed dials
- 4 Groups
- 5 Settings
- 6 Information

Call history

- 1 All calls
- 2 Missed calls
- 3 Dialed calls
- 4 Received calls
- 5 Call charges
- 6 Data information

Message

- 1 New text message
- 2 New multimedia message
- 3 New email message
- 4 Inbox
- 5 Email box
- 6 Drafts
- 7 Outbox
- 8 Sent

- 9 Voice mail
- 0 Info service
- 11 Templates
- 12 Settings

Browser

- 1 Home
- 2 Bookmarks
- 3 Go to URL
- 4 Settings



This icon refers to the menus related to Multimedia functions such as MP3, camera, video camera, FM radio.

My stuff

- 1 Images
- 2 Sounds
- 3 Videos
- 4 Documents
- 5 Others

Camera

Camcorder

Voice recorder

MP3 Player

- 1 All songs
- 2 Settings

FM Radio**Games & Apps**

- 1 Default games
- 2 Downloaded
- 3 Information
- 4 Settings



This icon refers to the menus related to Tool for user's convenience.

Alarm clock**Calculator****World clock****Unit converter**

- 1 Currency
- 2 Area
- 3 Length
- 4 Weight
- 5 Temperature
- 6 Volume
- 7 Velocity

Calendar**Memo**

This icon refers to the menus related to settings of device.

Display

- 1 Wallpaper
- 2 Backlight
- 3 Clock
- 4 Brightness
- 5 Theme
- 6 Network name

Profile

- 1 General
- 2 Silent
- 3 Vibrate only
- 4 Outdoor
- 5 Headset

Settings

- 1 Date & Time
- 2 Power saving
- 3 Languages
- 4 Call
- 5 Security
- 6 Connectivity
- 7 Flight mode
- 8 Reset setting
- 9 Memory status

Bluetooth

- 1 Bluetooth on/off
- 2 Device list
- 3 Bluetooth settings
- 4 Supported services

SIM service

This menu depends on SIM and the network services.

DIALLING (Menu 1)

This icon stands for the menu related to Call. If you select this icon, you can make a call, and send a message.

You can enter Dialling, Message and Contacts menu directly in standby mode by tapping the corresponding icon.



To make and receive calls, make sure that the phone is turned on. When the power is on and the PIN code is entered (or not, depending on setting of PIN code request) the phone automatically searches for the network registered in the SIM card.

To make a call tap the  icon and then enter Dialling menu. After the keypad is displayed on screen, enter the phone number.

CONTACTS (Menu 2)

1. Tap  icon or menu icon in standby mode.
2. Select **Contacts** menu.

Search (Menu 2.1)

1. Tap **Search** in **Contacts** menu.
2. You can view the list of contacts you saved.
3. If you want to edit, delete, or copy an entry, select  icon. The following menu will be displayed.
 - **New message:** After you have found the number you want, you can send a text/multimedia message, or an e-mail to the selected number.
 - **Delete:** You can delete an entry.
 - **Edit:** You can edit the name, number, group, character and picture by using the navigation key.
 - **New contact:** You can add new entry.
 - **Send contact via Text/Multimedia/E-mail/Bluetooth:** You can send the data of phonebook to other devices which is compatible with Bluetooth. You can also send text/multimedia/E-mail message with an entry saved in phonebook.
 - **Copy to SIM/phone:** You can copy the entry from SIM card or phone memory.
 - **Multiple delete:** You can delete the multiple entries at the same time.
 - **Search by 3x4:** You can search the entry by entering the name. This menu is displayed on activating search editor.

New contact (Menu 2.2)

You can add phonebook entry by using this function. The phone memory capacity is 1000 entries. The SIM card memory capacity depends on the SIM. The number of characters is a SIM dependent feature.

1. Select **New contact**.
2. Select the memory you want to save: **SIM** or **Phone**.
 - a. Tap the blank of name to input a name and tap [OK].
 - b. Input a number and tap [Save].

Maximum stored name and number length depends on SIM-card type.

- c. You can set a group for the entry by scrolling a bar.
- d. you can select a ringtone.
- e. You can set a character and a picture for the entry by scrolling a bar.

The step of c, d, and e only can be set for numbers stored on the phone, not on the SIM.

Speed dials (Menu 2.3)

You can assign any of the keys 2 to 9 with a Name list entry. You can call directly by tapping and holding this key. After assigning the number as speed dial, you can change and delete the entry. You can also send a message to this number.

1. Select **Speed dials**.
2. If you want to add a speed dial, select **(Empty)**. Then, you can search the name in the phonebook.
3. Select **[Assign]** in the middle of the bottom line.

Groups (Menu 2.4)

You can list up to the members per each group. There are 7 groups you can make lists to.

- **Set group ringtone:** Allows you to specify ring tone for the group members' call.
- **Set group icon:** Allows you to select the icon depending on Group.
- **Add member:** You can add a member to the selected group.
- **Remove member:** Allows you to remove a member from the group.
- **Rename:** You can change a group name.
- **Remove all:** Allows you to remove all the members from the group.

Settings (Menu 2.5)

1. Select Settings.

◦ **Copy all**

You can copy/move entries from the SIM card memory to the Phone memory and vice versa.

2. Select **Copy all**

- **SIM to Phone:** You can copy all entries from SIM Card to Phone memory.
 - **Phone to SIM:** You can copy all entries from Phone memory to SIM Card.
- **Delete all**
- You can delete all entries in the SIM card or phone. This function requires the security code.

Information (Menu 2.6)

◦ **Service dial numbers**

Use this function to access a particular list of services provided by your network operator (if supported by the SIM card).

◦ **Own number**

You can view your own number. If you use other SIM cards, you can save the new number by using <Add>.

◦ **Memory status**

You can check the status of SIM or phone memory.

◦ **Business card**

You can compose a business card. If you select **Edit**, you can make a new business card.

CALL HISTORY (Menu 3)

You can check the record of missed, received, and dialled calls only if the network supports the Calling Line Identification (CLI) within the service area.

The number and name (if available) are displayed together with the date and time at which the call was made. You can also view call times.

All calls (Menu 3.1)

You can view all lists of outgoing or incoming calls.

Missed calls (Menu 3.2)

This option lets you view the last 40 unanswered calls. You can also:

- View the number if available and call it, or save it in the phonebook.
- Enter a name for the number and save both in the phonebook.
- Send a message to this number.
- Delete the call from the list.

Dialled calls (Menu 3.3)

This option lets you view the last 40 outgoing calls (called or attempted).

You can also:

- View the number if available and call it or save it in the phonebook.
- Enter a name for the number and save both in the phonebook.
- Send a message to this number.
- Delete the call from the list.

Received calls (Menu 3.4)

This option lets you view the last 40 incoming calls. You can also:

- View the number if available and call it or save it in the phonebook.
- Enter a name for the number and save both in the phonebook.
- Send a message to this number.
- Delete the call from the list.

Call charges (Menu 3.5)

Call duration

Allows you to view the duration of your incoming and outgoing calls. You can also reset the call times.

The following timers are available:

- **Last call:** Length of the last call.
- **All calls:** Total length of all calls made and incoming calls since the timer was last reset.
- **Dialled calls:** Length of the outgoing calls.
- **Received calls:** Length of the received calls.

Call costs

Allows you to check the cost of **Last call** and **All calls**.

Settings

In this menu, you can change the settings after entering the PIN2 code.

- **Set credit:** This network allows you to limit the cost of your calls by selected charging units.

- **Set tariff:** You can set the currency type and the unit price. Contact your service providers to obtain charging unit prices. To select the currency or unit in this menu, you need the PIN2 code.
- **Auto display:** This network service allows you to see automatically the cost of your last calls. If set to **On**, you can see the last cost when the call is released.

Data information (Menu 3.6)

You can check the amount of data transferred over the network through the GPRS information option. In addition, you can also view how much time you are online.

Data time (Menu 3.6.1)

You can check the duration of Last session and All sessions. You can also reset the session timer.

Data volume (Menu 3.6.2)

You can check Sent, Received, All data volumes, and Reset all.

MESSAGE (Menu 4)

This menu includes functions related to SMS (Short Message Service), MMS (Multimedia Message Service), Email, voice mail, as well as the network's service messages.

New text message (Menu 4.1)

You can write and edit text message, checking the number of message pages.

1. Enter the **Message** menu.
2. If you want to write a new message, select **New text message**.
3. To make text input easier, use T9.
4. If you tap  icon, you can view submenus as follow:
 - **Insert:** You can insert symbols, images, sounds, text templates, phonebook entries, or your own business card.
 - **T9:** You can activate or cancel T9 mode.
 - **Writing language:** You can select the language.
 - **New T9 word:** You can add a new word by using T9 mode.
 - **Save to drafts:** You can save the message in drafts.
 - **Clear text:** You can delete all the text.
 - **Exit:** If you select Exit while writing a message, you can finish, and go back to message menu. The message you have written is not saved.

This phone supports EMS release 5 and is able to send colour pictures, sounds, text styles, etc.. The other party may not receive pictures, sounds or text styles you sent properly if the phone does not support such options.

New multimedia message (Menu 4.2)

You can write and edit multimedia messages, checking the message size.

1. Enter the **Message** menu.
2. If you want to write a new message, select **New multimedia message**.
3. You can create a new message or choose one of the multimedia message templates already made.

The maximum available file size that can be inserted into the MMS-message is 300 kb.

Options menu in To tab

- **Send:** You can send multimedia messages to multiple recipients, priorities your message, or send later.
- **Save:** You can save multimedia messages to drafts or as templates.
- **Contacts:** You can insert the contact to a message.
- **Recent messages:** You can view the latest number of messages.
- **Settings:** You can configure the settings to send the message.
- **Exit:** You can get back to the Message menu.

All messages will be automatically saved in the outbox folder, even after a sending failure.

Options menu in Subject tab

- **Send:** You can send multimedia messages to multiple recipients, priorities your message, or send later.
- **Save:** You can save multimedia messages to drafts or as templates.
- **Exit:** You can get back to the Message menu.

Options menu in Slide tab

- **Insert:** You can insert image, video, sound, slide, text template, contact, business card, vCard, and vCalendar.
- **Preview:** You can preview multimedia messages you wrote.
- **Save:** You can save multimedia messages to drafts or as templates.
- **Edit subject:** Modifies the subject of multimedia messages you chose.
- **Slide duration:** You can set a timer for slides, texts, pictures and sounds.
- **Exit:** You can get back to the Message menu.

If you preview a picture (50K) on writing a multimedia message, the loading duration will take around 5 seconds. You can't activate any keys during the loading time. After it has loaded you will be able to write the multimedia message.

New email message (Menu 4.3)

To send/receive an email, you should set up an email account.

1. You can input up to 20 email addresses in the To and Cc field.

Tip: To input "@", tap the  and select "@".

2. Key in the subject of the mail and tap OK.

Accounts (Menu 4.3.1)

You can set up email accounts by selecting **New**. Using  you can set the following values.

- **Set as default:** You can select a mail account as default.
- **Edit**
 - **Account name:** You can edit the Email account name.
 - **Email address:** Enter the email address given to you by your service provider.

- **My name:** Enter a user name.
- **Incoming mail server:** Enter the POP3 or IMAP4 address that receives your email.
- **User name:** Enter your email ID.
- **Password:** Enter your email password.
- **Outgoing mail server:** Enter the SMTP address and Port number of computer that sends your email.

Save: You can save the e-mail settings.

Advanced settings

- **Protocol type:** Choose your protocol type. (POP3/IMAP4)
- **Maximum receive size:** Set up the size of files that can receive(100KB/200KB/300KB).
- **Save to server:** Select On to save the file on the server.
- **Insert signature:** Select On to add your signature to your email messages.
- **Reply email address:** You can set up the reply email address.
- **Incoming port number:** Enter the POP3 or IMAP4 Port number that receives your email.
- **Outgoing port number:** Enter the SMTP address and Port number of computer that sends your email.
- **Outgoing mail authentication:** When you send the mail, you can set authentication whether or not.
- **Outgoing server ID:** Enter your email ID.
- **Outgoing server password:** Enter your email password.

Network profile (Menu 4.3.2)

A profile is the network information used to connect to the Internet.

There are default profiles for some operators stored in phone memory.

Signature (Menu 4.3.3)

You can make your signature.

- For each e-mail account you may save up to 20 messages (totally 100 for five accounts). In the Inbox folder you may save not more than 20 messages, in Drafts and Outbox folders - 5 messages, and in Sent folder up to 10 messages. In case Drafts, Outbox or Sent folder is full, and you try to save a new message to one of these folders, the oldest saved message will be automatically deleted.
- Maximum size for one sent message is 300 kb with attachments, and maximum size for one received message is 100 kb. In case you have received a message with more than 5 attachments, only 5 of them will be received. Some attachments may display incorrectly.

Inbox (Menu 4.4)

You will be alerted when you have received messages. They will be stored in the Inbox.

In the Inbox, you can identify each message by icons.

If the phone shows 'No space for SIM message', you have to delete some messages from the Inbox. If the phone displays 'No space for message', you can make space of each repository by deleting messages, media and applications.

* SIM message

SIM message means the message exceptionally stored in SIM card. You can move this message to the phone.

For notified multimedia message, you have to wait for downloading and processing of the message. To read a message, select one of the messages by pressing View.

- **Delete:** You can delete the current message.
- **Reply:** You can reply to the sender.
- **Reply all:** You can send a reply to all recipients.
- **Forward:** You can forward the selected message to another party.
- **Return call:** You can call back to the sender.
- **Information:** You can view information about received messages; Sender's address, Subject (only for Multimedia message), Message date & time, Message type, Message size.
- **Multiple delete:** After the messages you want to remove, you can delete the selected messages.
- **Delete all read:** You can delete all messages read.
- **Delete all:** You can delete all messages.

Email box (Menu 4.5)

When you access this menu, you can either connect to your remote mailbox to retrieve your new email messages, or you can view the previously retrieved email messages without logging in to the email server.

You can check the saved emails, drafts, outbox, and sent emails. In the Inbox, up to 20 emails are stored.

Drafts (Menu 4.6)

Using this menu, you can preset up to five multimedia messages that you use most frequently. This menu shows the preset multimedia message list.

The following options are available.

- **Edit:** Modifies the message you choose.
- **Delete:** Deletes the message you choose.
- **Information:** To view the information of the message.
- **Multiple delete:** After selecting the messages you want to remove, press OK and you can delete the selected messages.

- **Delete all:** Deletes all of the messages in the folder.

Outbox (Menu 4.7)

This menu allows to view the message which is about to send or is failed sending. After sending the message successfully, the message will be moved to sent menu.

- **Resend:** You can send the message. After sending the message, this will be moved to sent box.
- **Edit:** Modifies the message you choose.
- **Information:** You can check information of each message.
- **Delete:** You can delete the message.
- **Multiple delete:** After selecting the messages you want to remove, press OK and you can delete the selected messages.
- **Delete all:** You can delete all messages in outbox.

Sent (Menu 4.8)

This menu allows you to view the messages which are already sent. You can check the time and the contents of message.

Voice mail (Menu 4.9)

Once this menu has been selected, simply tap [OK] to listen to voice mail. You can also tap and hold down the **1** key in dial mode to listen to voice mail.

When you receive a voice mail, your phone displays the icon and you hear an alert. Please check with your network provider for details of their service in order to configure the handset correctly.

Info service (Menu 4.0)

(Dependent to network and subscription)

Info service messages are text messages delivered by the network to the your phone. They provide general information such as weather reports, traffic news, taxis, pharmacies, and stock prices. Each type of has the number; therefore, you can contact the service provider as long as you have input the relevant number for the information you want. When you have received an info service message, you can see the popup message to show you that you have received a message or the info service message is directly displayed. To view the message again or not in standby mode, follow the sequence shown below;

Read (Menu 4.0.1)

1. When you have received an info service message and select Read to view the message, it will be displayed on the screen. You can read another message by scrolling |.
2. The message will be shown until another message is reached.

Topic (Menu 4.0.2)

(Dependent to network and subscription)

- **Add new:** You can add info service message numbers in the phone memory with its nickname.
- **View list:** You can see info service message numbers which you added. If you tap **+** icon, you can edit and delete info message category which you added.
- **Active list:** You can select info service message numbers in the active list. If you activate an info service number, you can receive messages sent from the number.

Templates (Menu 4.11)

Text template (Menu 4.11.1)

You have 6 text templates as below;

- **Please call me back.**
- **I'm late. I will be there at**
- **Where are you now?**
- **I am on the way.**
- **Urgent! Please contact.**
- **I love you.**

Multimedia template (Menu 4.11.2)

If you the template list is empty, you can add new template by tapping New. If the template is existed, you can view submenus as follow:

- **Edit:** You can edit multimedia templates.
- **Send:** You can send a message with multimedia template.
- **Delete:** You can delete multimedia templates.
- **New template:** You can write and send multimedia messages.
- **Delete all:** Allows you to delete all multimedia messages.

Settings (Menu 4.12)

Text message (Menu 4.12.1)

If you select this menu, you can tap the submenus in bar as follow:

- **Service centre:** If you want to send the text message, you can receive the address of SMS centre through this menu.
- **Delivery receipt:** If you set to Yes, you can check whether your message has been delivered successfully.

- **Validity period:** This network service allows you to set how long your text messages will be stored at the message centre.
- **Reply charging:** When a message is sent, it allows the recipients to reply and charge the cost of the reply to your telephone bill. This service is dependant on your service provider.
- **Message type:**
Text, Voice, Fax, Natl. paging, X.400, E-mail, ERMS

Usually, the type of message is set to **Text**. You can convert your text into alternative formats. Contact your service provider for the availability of these functions.

Multimedia message (Menu 4.12.2)

If you select this menu, you can tap the submenus in each bar.

- **Slide duration:** You can set the duration of each slide.
- **Priority:** You can set the priority of the message you choose.
- **Validity period:** This network service allows you to set how long your text messages will be stored at the message centre.
- **Delivery report:** If it is set to Yes in this menu, you can check whether your message has been delivered successfully.
- **Read report:** If it is set to Yes in this menu, you can check whether the receiver has read the message or not.
- **Auto download:** If you select On, you receive multimedia messages automatically. If you select Off, you receive only notification message in the inbox and then you can check this notification. If you select Home network only, you receive multimedia messages only when using your home network.

- **Network profile:** If you select multimedia message server, you can set the URL for multimedia message server.
- **Permitted msg type**
 - Personal:** Personal message.
 - Advertisement:** Commercial message.
 - Information:** Necessary information.

Email (Menu 4.12.3)

This menu allows you to edit, delete or add an email account.

- **Accounts**

You can set email accounts by selecting Add new. Using the Edit menu, you can edit the setting values. For details, please refer to page 35 and 36.
- **Network profile**

You can activate the profile saved as a default.
- **Signature**

You can make your signature.

Voicemail number (Menu 4.12.4)

You can receive the voicemail if your network service provider supports this feature. When a new voicemail arrives, the symbol will be displayed on the screen. Please check with your network service provider for details of their service in order to configure the phone accordingly.

Push message (Menu 4.12.5)

You can set the option whether you will receive the message or not.

Info message (Menu 4.12.6)

- **Receive**
 - On:** If you select this menu, your phone will receive Info service messages.
 - Off:** If you select this menu, your phone will not receive Info service messages.

- **Alert**
 - On:** Your phone will beep when you have received Info service message numbers.
 - Off:** Your phone will not beep even though you have received info service messages.
- **Language**

You can select the language you want. Then, the info service message will be shown in the language that you selected.

BROWSER (Menu 5)

You can access various WAP (Wireless Application Protocol) services such as banking, news, weather reports and flight information. These services are specially designed for mobile phones and they are maintained by WAP service providers.

Check the availability of WAP services, pricing and tariffs with your network operator and/or the service provider whose service you wish to use. Service providers will also give you instructions on how to use their services.

Once connected, the homepage is displayed. The content depends on the service provider. To exit the browser at any time, press the () key. The phone will return to the idle menu.

Navigating with the WAP browser

You can surf the Internet using either the phone keys or the WAP mobile browser menu.

Using the WAP browser menu

There are various menu options available when surfing the Mobile Web.

The WAP browser menus may vary, depending on your browser version.

Home (Menu 5.1)

Connects to a homepage. The homepage will be the site which is defined in the activated profile. It will be defined by the service provider if you have not defined it in the activated profile.

Bookmarks (Menu 5.2)

This menu allows you to store the URL of favourite web pages for easy access at a later time.

To create a bookmark

1. Select  icon.
2. Select **New**.
3. After entering the desired URL and name, tap **Save**.

After selecting a desired bookmark, the following options are available.

- **View:** You can check the name and URL saved as a bookmark.
- **Edit:** You can edit the URL and/or the name of the selected bookmark.
- **New:** Select this to create a new bookmark.
- **Delete:** Deletes the selected bookmark.
- **Send URL:** You can send the URL saved as a bookmark.
- **Delete all:** Deletes all the bookmarks.

Go to URL (Menu 5.3)

You can connect directly to the site you want. After entering a specific URL, tap **Connect**.

Settings (Menu 5.4)

You can set the profile, cache, cookie and security related to internet service.

Network profile (Menu 5.4.1)

A profile is the network information used to connect to the Internet.

There are default profiles for some operators, stored in phone memory. It's impossible to rename default profiles.

Each profile has submenus as follows:

- **View:** You can view the selected profile.
- **Edit:** You can change the profile name.
- **New profile:** You can add a new profile.
- **Reset all:** Deletes the selected profile from the list.

Cache (Menu 5.4.2)

The information or services you have accessed are saved in the cache memory of the phone.

- **Clear cache:** Removes all context saved in cache.
- **Allow cache:** If you select On, you can use cache memory to save the contents temporarily.

Security certificates (Menu 5.4.3)

A list of the available certification is shown.

Information (Menu 5.4.4)

You can view the version of WAP browser.

MULTIMEDIA

If you tap the Multimedia icon, you can enter the menu related to Multimedia such as camera, video camera, voice recorder, MP3, Radio, and Java games.

Do not change the default folder names, or it will not work properly.

MY STUFF (Menu 1)

Images (Menu 1.1)

Show the list of JPG/BMP/GIF/PNG files at Default images or Downloaded folder. You can view the taken picture and downloaded image from WAP. If you tap the image in list view or thumbnail view, you can view the normal image.

You can create new folder by connecting USB driver.

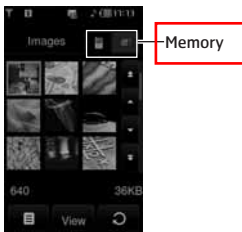

If you tap  icon in a JPG/BMP/GIF/PNG list, you can view the submenus as follows (in Thumbnail view):

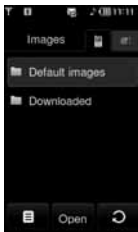

- **Send via:** You can send the image through MMS /Email/Bluetooth.
- **Set as wallpaper:** You can set the image as a wallpaper. The wallpaper is supported by full screen/adjust screen/original mode.
- **Delete:** You can delete the selected image.
- **File:**
 - **Rotate image:** You can rotate image with an angle of 90°/180°/270°.
 - **Rename:** You can change the name of file.
 - **Move/Copy:** You can move or copy image between internal memory and external memory.
 - **Information:** Shows the file information.
- **Print via Bluetooth:** You can print the selected file to another device via Bluetooth.
- **View as slide show:** You can view the JPG/BMP /GIF/PNG file as slide show.
- **Multiple delete:** You can delete multiple files at the same time.
- **Delete all:** Deletes all files in the list.
- **List view:** You can view the JPG/BMP/GIF/PNG list.

If you tap  icon in a JPG/BMP/GIF/PNG list, you can view the submenus as follows (in List view):

- **Send via:** You can send the image through MMS/Email/Bluetooth.
- **Set as wallpaper:** You can set the image as a wallpaper. (Only for JPG/BMP/PNG)
- **Delete:** You can delete the selected image.
- **File:**
 - **Rotate image:** You can rotate image with an angle of 90°/180°/270°.
 - **Rename:** You can change the name of file.
 - **Move/Copy:** You can move or copy image between internal memory and external memory.
 - **Information:** Shows the file information.
- **Print via Bluetooth:** You can print the selected file to another device via Bluetooth.
- **View as slide show:** You can view the JPG file as a slide show.
- **Delete:** Deletes a file.
- **Multiple delete:** You can delete multiple files at the same time.
- **Delete all:** Deletes all files in the list.
- **Thumbnail view/List view :** You can view the JPG/BMP/GIF/PNG file as a thumbnail/list image.

- You can store .JPG (.JPEG) files in both the phone and memory card in the Photos folder. In the Images folder in both the phone and external memory you may store JPG, BMP, PNG, GIF, WBMP and other image format files.

- To setup a JPG/BMP/GIF/PNG file from the Photo folder as wallpaper, go to Menu-Multimedia-Photo album and then select Set as wallpaper in Options menu.

- You cannot set GIF, Ani GIF, Animated GIF, Transparent GIF, and Progressive JPG file as a wallpaper.

Sounds (Menu 1.2)

Shows the list of MP3, AAC, WMA, I-MELODY, WAVE, MIDI, AMR, MMF, **M4A** files at Default sounds, Downloaded, Voice records and MP3 folder.

If you tap  icon in a list, you can view the menu as follows:

- **Send via:** You can send the sound file on writing the message.
- **Set as ringtone:** You can set the sound as a ringtone.
- **File:** You can view the file and DRM information.
- **Delete:** Deletes a file.
- **Multi delete:** You can delete multiple files at the same time.
- **Delete all:** Deletes all files in the list.

Videos (Menu 1.3)

Shows the list of MP4, 3GP files in the Downloaded folder.

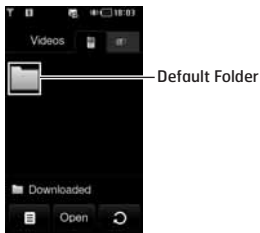

Downloaded folder is set by default. You cannot edit or delete the default folder. You can save the file downloaded from the network service in this folder.

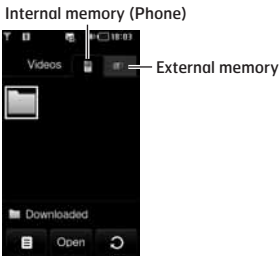

If you don't insert the external memory card into a phone, the warning message "No external memory inserted" will be displayed.

- **Thumbnail view/List view:** You can view the file list.

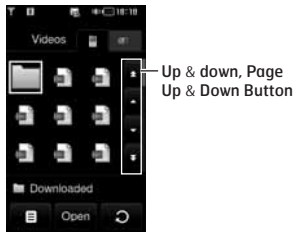

If the folder has video files over 9, up/down and page up/down icons will be shown up on the right side of screen.

If you tap the  icon in a list, you can view the submenus as follows (in Thumbnail view):

- **Send via:** Send the selected file to another device via MMS, Email and Bluetooth.

You can't use the following characters, \ / : * ? " < > |

- **Delete:** Delete a file.
- **File:**
 - **Rename:** You can change the name of file.
 - **Move/Copy:** You can move or copy image between internal memory and external memory.
 - **Information:** Shows the file information.
- **Delete all:** Delete all files in the list except default files and folder.
- **Multiple delete:** You can delete multiple files at the same time. If you mark v on the check box by tapping the screen, you can delete the selected file or cancel the actions.

The maximum available file size that can be inserted into the MMS-message and email is 300kb. If you try to attach the file over 300kb, the warning message "Oversized" will be displayed, and then the actions will be canceled automatically.

When you open the video file in folder, you can use the functions as follow:

The video player supports:

- Video Codec : **MPEG4,H.263**
- Audio Codec : **AAC,AMR**
- Resolution : 128X96, 176X144, 320X240, 352X288, 400X240, 176x120, 240x176, 320x176, 368x208, 384x160, 400x192, 416x176, 480x160
- File Extension : **.3gp,.mp4**



Normal view

- You can set the volume of video file by pressing volume soft key.
- If you convert the screen to wide version, you can use the functions as follow:



ICON	DESCRIPTION
	Checks the running time of video file. Taps the bar to turn the indicating position.
	Sends the video file by MMS
	Touch lock key
	Controlling the volume
	Wide view
	Rewind
	Pause or Play
	Fast Forward
	Converts to normal view.

You cannot listen to the sound with Bluetooth headset on playing the video file.

You can convert the screen horizontally by selecting Landscape menu in option. The default mode is full screen.(400X240)



Full image



Wide screen



Full screen

You can set the video file as a wallpaper as follow:

- JPG: Not supported Greay scale format, Progressive format
- BMP: Maximum up to 24bit
- PNG : No limit

Documents (Menu 1.4)

Show the text documents in SIM or phone memory. After opening the file, you can view the submenus by tapping **⏏** icon.

- **Landscape:** You can read the text in landscape.
- **Go to page:** You can go the selected page directly without searching it.

- **Set magnification:** You can magnify it by tapping the icon.
- **View setting:** You can set the size of text by using Fit to height and Fit to width menus.
- **Bookmark setting:** If you select On, you can go back to the latest page you opened directly. You can save the documents as a bookmark up to 100.

- If the file has over 300 lines, it may not be opened properly.
- You can open the file the maximum of up to 10MB.
- The display screen for loading can be stopped if the file size is exceeded the maximum.

Others (Menu 1.5)

Show the list of files in My media\Others in the Multimedia memory.

- **Send via:** Send the selected file to another device via Email or Bluetooth.
- **Delete:** Delete a file.
- **File:** You can edit the file name. You can also copy and move the file.
- **Multiple delete:** You can delete multiple files at the same time.
- **Delete all:** Delete all files in the list.

DRM (Digital Rights Management)

As a result of the Digital Rights Management (DRM) system, some of the media items you download from the Internet or receive by MMS may have a "Purchase right" menu to access them. You can acquire the key to purchase the right from the website which owns the rights to the contents.

CAMERA (Menu 2)

Do one of the following to display the camera capture screen:

1. Press the **1** key at least two seconds to enter camera capture mode directly. Or, tap the Multimedia icon, and then select **Camera** menu.
2. Focus on the subject to capture the image, and then press the **1** key.
3. You can save the picture automatically.

Before taking a picture, you can view the menu as follows:



Menu	Icon	Description
Mode		Allows you to take a picture.
		Allows you to take a moving image.
Zoom		Allows you to set the zooming value.
Flash ON/OFF		Allow you to set the flash when you take a photo in dark place.
Resolution		320X240, 640X480, 1280X960, 1600X1200

Menu	Icon	Description
Meter		All, Centre
Filter		Off, Negative, Gray, Sepia
Quality		Normal, Fine, Super fine
AF, ON/OFF		Automatically adjusts the focus for a clear, sharp image with a single press of a button.
Multishot		Allows to take multishot photos successively. - QVGA (1,3,6) - VGA (1,3) - ONE_MEGA (1) - TWO_MEGA (1)
View		4:3, 16:9
Storage		You can select a storage space; Phone or Memory card.
Timer		Allows you to select the delay time (Off, 3 Seconds, 5 Seconds, 10 seconds). Then the phone takes a photo after the specified time.
Shutter tone		Shutter1, Shutter2, Shutter3
WB		Auto, Tungsten, Fluorescent, Daylight, Cloudy

If you tap on the screen, you can view the menu as follows:

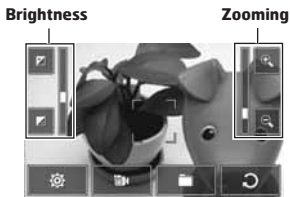

Menu	Icon	Description
Setting		You can change the setting.
Mode		You can change the mode from camera to camcorder.
Folder		You can move the picture to each folder.
Cancel		You can go back to previous menu.

After taking a picture, you can check the menu as follows:

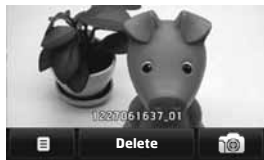

Menu	Icon	Description
Option		If you tap this icon after taking a picture, you can set it as a wallpaper or send a message via MMS, Email.
Delete		If you don't want to save the picture, you can delete it.
Camera		You can take a picture.

CAMCORDER (Menu 3)**1. Select Camcorder menu.**

Once the settings are displayed on the screen, you can scroll through them touching the icons. Scroll to the setting you wish to change, tap the screen and it will bring up the setting values. Scroll to your preferred choice.

2. To start recording press . As soon as it starts to record a timer will be displayed.



Recording
time



**Same as Camera settings except of Duration.
For details, refer to P.47.**

Menu	Icon	Description
Duration		You can check the recording duration in this menu. (Multimedia msg/ No limit)

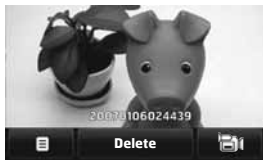
3. Press the  to end the recording and this will now be saved.



After taking a moving image, you can check the menu as follow:

Menu	Icon	Description
Option		If you tap this icon after taking a picture, you can set it as a wallpaper or send a message via MMS, Email.
Delete		If you don't want to save the picture, you can delete it.
Video camera		You can take a video.

VOICE RECORDER (Menu 4)

You can record voice memo in Voice recorder menu.

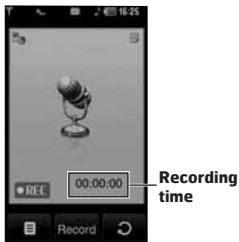

Recording time

If you select **REC** with no voice file, you can view the submenus as follow:

- **My stuff:** You can enter the Voice records menu directly.
- **Storage:** You can select the storage to save the voice in phone or external memory.
- **Recording mode:** You can select the proper mode of No limit or Multimedia msg.

In No limit mode, you can record the voice as an MP3. But if you record the voice during a call or in multimedia msg mode it will be recorded as an AMR.

1. Once recording is started, the message Recording and the remaining time is displayed.
2. If you want to finish recording, press the center key Stop.

If you tap Option **REC** after saving the voice memo, you can view the submenus as follow:

- **New voice record:** You can record new voice memo.
- **Send via:** You can send the voice memo via MMS, Bluetooth, infrared or E-mail.
- **My stuff:** You can access the Sounds folders.

MP3 PLAYER (Menu 5)

All songs (Menu 5.1)

The KE850 Has an integrated MP3 player built-in. You can enjoy listening to MP3 music files on a memory in your phone using a compatible headset or via the internal loudspeaker.

Because of the small dimension of the speaker, in some cases the audio could be distorted, especially at maximum volume and when there are lots of bass sounds. Therefore, we recommend you to use the stereo headset in order to appreciate the high quality of your music.

The music player supports:

- **MPEG-1 Layer III, MPEG-2 Layer III, MPEG-2.5 Layer III:** Sampling frequency up from 8KHz to 48KHz. Bit rate up to 320Kbps, stereo.
- **AAC:** LC (Low complexity)
- **AAC+:** V1: (Bit rate 16-128Kbps)
V2: (Bit rate 16-48Kbps)
(Sampling frequency from 8KHz to 48KHz)
- **WMA, RA**

The KE850 doesn't support the variable bit rate of all mentioned file types. Therefore, you can't change the file from MP3 format to AAC.

You can transfer MP3 files from a compatible PC to the memory in your phone using the Mass Storage.

When you connect the phone to a PC using the USB cable (supplied in the box), the phone will be recognised as a removable disk through windows explorer. After you copy songs to the removable disk, you should execute the safe removal of hardware from your system. Never remove the cable from the PC or phone while data is transferring as this can seriously damage the phone.

- You should copy MP3 tracks to **Sounds\MP3 folder**. If you copy to any other folder, you can't see or play the MP3 files.
- The PC should run **Windows 2000, Windows XP operating system**.

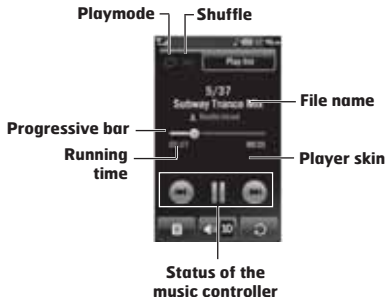

In case an invalid file is included in the playlist, the menu will return back to the play list.

1. Press the MP3 key on the side of the phone to open the MP3 player. Then select the play list to play.
2. Press the left soft key **[Options]** to access the following menus.
 - **Set as ringtone:** You can set as a ringtone the current music on playing MP3 file.
 - **Settings:** You can set up various functions such as shuffle, repeat.

Playlist (Menu 5.1.1)

This menu allows to view the whole play list. You can move the track by pressing the navigation key. In addition, if you select the option menu, you can delete the file or view its information.

Settings (Menu 5.2)

- **Shuffle**
If you select On, the tracks will be played randomly.
- **Repeat**
This menu allows to set the play mode: Off, Repeat all, Repeat one.
- **Player skin**
You can select the visual effect menus: White skin and Black skin. This menu allows you to change the background of the display.

Music is copyright protected in international treaties and national copyright laws. It may be necessary to obtain permission or a license to reproduce or copy music. In some countries national law prohibits private copying of copyrighted material. Please check the national legislation of the applicable country concerning the use of such material.

When an MP3 is playing on the MP3 player, if you press MP3 short key, you can use BGM mode. In BGM mode MP3 can be played while other functions are being used. BGM can be stopped on the MP3 player screen.

FM RADIO (Menu 6)

Radio (Menu 6.1)

You can search radio stations and enjoy listening to the radio.

- To improve the radio reception, extend the headset cord which functions as the FM antenna.
- You cannot use FM radio without headset.

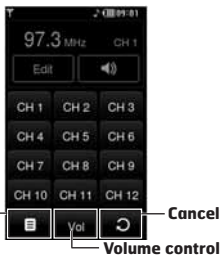

1. Tap the corresponding number key of a channel to store the currently selected radio station into.
2. After presetting the radio channels, you can listen to all the preset channels.
3. You can adjust frequency and change the radio station in the selected channel. You can search for the next station by tapping for at least two seconds or pressing the side keys.



4. You can access the following option menus by pressing the left soft key [Options].



- **Auto scan:** If you select "Auto Scan Now?" to On, it automatically sets the radio channels. When "Save this Station?" message appears, if you select Yes, the selected frequency will be stored.
- **Reset channels:** You can reset all channels at 87.5Mhz.

- You can lock the FM radio function by pressing side lock key.
- You cannot switch on the backlight by pressing the clear key or touching the keypad if the function is locked.

GAMES & APPS (Menu 7)

In this menu, you can manage the Java applications installed in your phone. You can play or delete downloaded applications, or set the connect option.

Default games (Menu 7.1)

You can enjoy four default games. If you want to know the contents of games, you can use Help in a game.

Downloaded (Menu 7.2)

You can play the downloaded games from the network.

Information (Menu 7.3)

You can check the Java version installed in a phone.

Settings (Menu 7.4)

To download a game, you can set the value to connect the network in this menu.

TOOLS

You can use various tools installed in the phone such as alarm, calculator, world clock, unit converter, and scheduler.

ALARM CLOCK (Menu 1)

You can set alarm clocks to go off at a specified time.



1. Select **On** and enter the alarm time you want.

- 🛎️ : You can set the alarm by tapping On or Off.
- 🕒 : You can set the specified time to alert.
- 🕒 : You can set the repeat duration for alarm.
- 🎵 : You can set the alarm tone in each folder.
- 📝 : You can input the memo for alarm. When the alarm alerts, you can view the memo.

After setting each value, tap **Save**.

You can set multiple alarms up to 5.

CALCULATOR (Menu 2)

This contains the standard functions such as +, -, *, / : Addition, Subtraction, Multiplication and Division.

Furthermore, you can use the various function of calculator such as +/-, sin, cos, tan, log, ln, exp, deg, rad by tapping Science bar.

1. Input the numbers by tapping numeric keys.
2. If you want the complicate calculation such as sin, cos, tap **☰** key.
3. If you input wrong number, tap **✖** key.
4. Tap = key to view the result.
5. To end **Calculator**, tap **⏏**.

WORLD CLOCK (Menu 3)

You can check the time of selected major city in world by dragging around the screen of world map. You can zoom in, and use the arrow keys to find the correct city.

UNIT CONVERTER (Menu 4)

This converts any measurement into a unit you want. There are 7 types that can be converted into units: **Currency, Area, Length, Weight, Temperature, Volume and Velocity.**



Unit type

1. You can select one of seven unit types by tapping the menu.
2. Input the number you want to convert in each bar. It's impossible to input "-" symbol in unit converter.
3. If you want to reset the value, tap **Reset**.

CALENDAR (Menu 5)

When you enter this menu a calendar will show up. On top of the screen there are sections for date. Whenever you change the date, the calendar will be updated according to the date. A square cursor will be used to locate the specific day. If you see a marked date in the calendar, it means that there is a schedule or memo on that day. This function helps to remind you of your schedule and memo. The phone will sound an alarm tone if you set this for the note. To change the day, month, and year:



If you tap each day/month/year area, you can change it.

If you select  icon, you can view the menu as follows:

- **Delete past:** You can delete the past schedules.
- **Delete all:** You can delete all schedules.
- **Go to Date:** You can go the selected date directly.

MEMO (Menu 6)

If you select  icon after entering the menu, you can view the submenu as follows:

- **New:** You can create new memo.
- **Send via BT/Email/SMS/MMS:** You can send the memo via Bluetooth, E-mail, SMS and MMS.
- **Multiple delete:** You can delete the selected memos at once.
- **Delete:** You can delete the memo.
- **Delete all:** You can delete all memos.

SETTINGS

You can configure the settings related to the phone.

DISPLAY (Menu 1)

Wallpaper (Menu 1.1)

You can select the background pictures in standby mode.

A few items of background such as the butterfly or the clock can move with a finger.

Backlight (Menu 1.2)

You can set the light-up duration of the display.

Clock (Menu 1.3)

You can select the various clock types to display.

Brightness (Menu 1.4)

You can set the brightness of the LCD: 100%, 80%, 60%, 40%

Theme (Menu 1.5)

You can set the theme of display: PRADA theme, Blue theme, Butterfly theme, and Fish theme.

The phone will display different top menus depending on the theme.

Network name (Menu 1.6)

If this function is activated, network name will be displayed on main LCD.

PROFILE (Menu 2)

In **Profile**, you can adjust and customise the phone tones for different events, environments, or caller groups.

There are five preset profiles: **General**, **Silent**, **Vibrate only**, **Outdoor**, and **Headset**. Each profile can be personalised.

Activate (Menu 2.X.1)

1. A list of profiles is displayed.
2. In the Profiles list, scroll to the profile you want to activate and tap **Activate**.

Personalise (Menu 2.X.2)

Scroll to the desired profile in the Profile list, and then tap **Personalise**.

- **Call alert type:** Set the alert type for incoming calls.
- **Ringtones:** Select the desired ring tone from the list.
- **Ring volume:** Set the volume of the ringing tone.
- **Message alert type:** Set the alert type for messages.
- **Message tones:** Select the alert tone for messages.
- **Touch tones:** Select the desired touch and keypad tone.
- **Touch volume:** Set the volume of touch and keypad tone.
- **Effect sound volume:** Set the volume of effect sound.
- **Power on/off volume:** Set the volume of the ringing tone when switching the phone on/off.
- **Auto answer:** This function will be activated only when your phone is connected to the handsfree kit.
 - **Off:** The phone will not answer automatically.

- **After 5 secs:** After 5 seconds, the phone will answer automatically.
- **After 10 secs:** After 10 seconds, the phone will answer automatically.

SETTINGS (Menu 3)

Date & Time (Menu 3.1)

You can set the date and time.

Date (Menu 3.1.1)

You can enter the current date.

Date format (Menu 3.1.2)

You can set the date format such as YYYY/MM/DD, DD/MM/YYYY, MM/DD/YYYY.
(D: Day / M: Month / Y: Year)

Time (Menu 3.1.3)

You can enter the current time.

Time format (Menu 3.1.4)

Your can set the time format between 24-hour and 12-hour.

Auto update (Menu 3.1.5)

(Network dependent)

If you select On, the date and time setting will be updated automatically.

Power saving (Menu 3.2)

If you set On, you can save the power when you don't use the phone.

Languages (Menu 3.3)

You can change the language for the display texts in your phone. This change will also affect the Language Input mode.

Call (Menu 3.4)

You can set the menu relevant to a call by tapping Setting menu.

Call divert (Menu 3.4.1)

The Call divert service allows you to divert incoming voice calls, fax calls, and data calls to another number. For details, contact your service provider.

◦ All voice calls

Diverts voice calls unconditionally.

◦ If busy

Diverts voice calls when the phone is in use.

◦ If no reply

Diverts voice calls which you do not answer.

◦ If out of reach

Diverts voice calls when the phone is switched off or out of coverage.

◦ All data calls

Diverts to a number with a PC connection unconditionally.

◦ All fax calls

Diverts to a number with a fax connection unconditionally.

◦ Cancel all

Cancels all call divert service.

The submenus

Call divert menus have the submenus shown below.

- Activate

Activate the corresponding service.

To voice mail centre

Forwards to message centre. This function is not shown at All data calls and All fax calls menus.

To other number

Inputs the number for diverting.

To favourite number

You can check recent 5 diverted numbers.

- Cancel

Deactivate the corresponding service.

- View status

View the status of the corresponding service.

Send my number (Menu 3.4.2) (network and subscription dependent)

- **Set by network**
If you select this, you can send your phone number depending on two line service such as line 1 or line 2.
- **On**
You can send your phone number to another party. Your phone number will be shown on the receiver's phone.
- **Off**
Your phone number will not be shown.

Call waiting (Menu 3.4.3) (network dependent)

- **Activate**
If you select **Activate**, you can accept a waiting (receiving) call.
- **Cancel**
If you select **Cancel**, you cannot recognize the waiting (receiving) call.
- **View status**
Shows the status of Call waiting.

Minute minder (Menu3.4.4)

If you select **On**, you can check the call duration by a beep sound given every minute during a call.

Auto redial (Menu 3.4.5)

- **On**
When this function is activated, the phone will automatically try to redial in the case of failure to connect a call.
- **Off**
Your phone will not make any attempts to redial when the original call has not connected.

Send DTMF tones (Menu 3.4.6)

You can send touch tones during an active call to control your voice mailbox or other automated phone services.

Information

DTMF tone: Dual Tones Multiple Frequency.

Select line (Menu 3.4.7) (SIM dependent)

This menu is shown only if the SIM supports two subscriber numbers, that is, two phone lines. Select which phone line (between Line 1 and Line 2) you want to use for making calls and sending short messages. Calls on both lines can be answered irrespective of the selected line.

Security (Menu 3.5)

Request PIN code (Menu 3.5.1)

In this menu, you can set the phone to ask for the PIN code of your SIM card when the phone is switched on.

If this function is activated, you'll be requested to enter the PIN code.

1. Select **Request PIN code** in the security settings menu.
2. Set **Enable/Disable**.
3. If you want to change the setting, you need to enter PIN1 code when you switch on the phone.
4. If you enter wrong PIN1 code more than 3 times, the phone will lock out. If the PIN1 is blocked, you will need to key in PUK code.
5. You can enter your PUK code up to 10 times. If you put wrong PUK code more than 10 times, you can not unlock your phone. You will need to contact your service provider.

Auto key lock (Menu 3.5.2)

If you activate this function, the key will be locked automatically in standby mode without requesting the action of key.

Handset lock (Menu 3.5.3)

You can use a security code to avoid unauthorized use of the phone. Whenever you switch on the phone, the phone will request security code if you set phone lock to When switch on.

If you set phone lock to When SIM changed, your phone will request security code only when you change your SIM card.

Call barring (Menu 3.5.4)

The Call barring service prevents your phone from making or receiving certain category of calls. This function requires the call barring password. You can view the following submenus.

- **All outgoing calls**
The barring service for all outgoing calls.
- **Outgoing international**
The barring service for all outgoing international calls.
- **Outgoing international when roaming**
The barring service for all international outgoing calls except home network.
- **All incoming**
The barring service for all incoming calls.
- **Incoming when roaming**
The barring service for all incoming calls when roaming.
- **Cancel all**
You can cancel all barring services.
- **Change password**
You can change the password for Call Barring Service.

The submenus:

- **Activate**
Allows to request the network to set call restriction on.
- **Cancel**
Set the selected call restriction off.
- **View status**
View the status whether the calls are barred or not.

Fixed dial number (Menu 3.5.5)

(SIM dependent)

You can restrict your outgoing calls to selected phone numbers. The numbers are protected by your PIN2 code.

- **On**
You can restrict your outgoing calls to selected phone numbers.
- **Off**
You can cancel fixed dialling function.
- **Number list**
You can view the number list saved as fixed dial number.

The default security code for this phone is 0000. The PIN 1 and PIN 2 and related to the SIM card and your service provider.

Change codes (Menu 3.5.6)

PIN is an abbreviation of Personal Identification Number to prevent use by unauthorized person. You can change the access codes: **Security code, PIN1 code, PIN2 code.**

1. If you want to change the Security code/PIN1/PIN2 code input your original code, and then tap [OK].
2. Input new Security code/PIN/PIN2 code and verify them.

Connectivity (Menu 3.6)

Network selection (Menu 3.6.1)

You can select a network type.

- **Automatic:** If you select **Automatic** mode, the phone will automatically search for and select a network for you. Once you have selected “**Automatic**”, the phone will be set to “**Automatic**” even if you turn your phone off and on.
- **Manual:** The phone will find the list of available networks and show them on a list. Then you can select the network which you want to use if this network has a roaming agreement with your home network operator. The phone allows you select another network if the phone fails to access the selected network.
- **Preferred:** You can set a list of preferred networks and the phone attempts to register with first, before attempting to register to any other networks. This list is set from the phone's predefined list of known networks.

Network profile (Menu 3.6.2)

A profile is the network information used to connect to the Internet.

There are default profiles for some operators stored in phone memory. It's impossible to delete default profiles.

GPRS attach (Menu 3.6.3)

You can set GPRS service depending on various situations.

◦ **Switch on**

If you select this menu, the phone is automatically registered to a GPRS network when you switch the phone on. Starting a WAP or PC dial-up application created the connection between phone and network and data transfer is possible. When you end the application, GPRS connection is ended but the registration to the GPRS network remains.

◦ **When needed**

If you select this menu, the GPRS connection is established when you connect a WAP service and closed when you end the WAP connection.

USB connection (Menu 3.6.4)

You can use your phone with a variety of PC connectivity and data communications applications though USB.

Flight mode (Menu 3.7)

If you activate the Flight mode, you can use the phone without connecting to the GSM wireless network. You can still do tasks which do not require the use of wireless network. With Flight mode you cannot make any calls including of emergency calls or use other features that require network service.

Reset setting (Menu 3.8)

You can initialize all factory defaults. You need Security code to activate this function.

- **Restore default settings:** Allows you to restore default settings.
- **Clear multimedia memory:** Allows you to format the multimedia memory and create a default directory.
- **Clear external memory:** Allows you to format all data in the external memory.

Memory status (Menu 3.9)

You can check free space and memory usage of each repository, Internal memory, Multimedia memory and external memory. You can go to each repository menu.

BLUETOOTH (Menu 4)

Bluetooth enables compatible mobile devices, peripherals and computers that are in close proximity to communicate directly with each other without wires. This handset supports built-in Bluetooth connectivity, which makes it possible to connect them with compatible Bluetooth headsets, computer applications and so on.

- If you use a pcsync via Bluetooth, you can exchange the data within only the phonebook.
- When you receive data from another Bluetooth device, the phone requests a confirmation. After confirming the transfer, the file will be copied in your phone.
- Depending on the file type, it will be stored in the following folders:
 - MP3(.mp3, mp4, aac, wma): Music folder.
 - Video (.3GP): Video folder.
 - Phonebook contacts (.VCF): Phonebook.
 - Text(.txt): Text folder.
 - Other files (.*) : File storage folder.
- Supported Bluetooth software (Bluetooth stacks) for DUN: Recommended drivers WidComm Bluetooth for Windows 1.4 and 3.0.

Bluetooth on/off (Menu 4.1)

You can activate or cancel the Bluetooth in this menu.

Device list (Menu 4.2)

You can view all devices which are compatible with Bluetooth on your phone.

Due to a compatibility problem, some devices may not support this function.

Bluetooth settings (Menu 4.3)

You can register a new device which is compatible with Bluetooth. If you already have added the device, you can search it after entering the password.

- **My visibility**
You can set the function so that your phone is shown on the other peoples Bluetooth devices.
- **My name**
You can set the name of your Bluetooth device. The default name is KE850.
- **My address**
You can check the address of Bluetooth device you activated.

Supported services (Menu 4.4)

You can view the list of devices such as headsets and handsfree kits supported by this Bluetooth enabled phone.

Print via Bluetooth: It is available in printers which support Basic Printing Profile. You can print with "Send via Bluetooth" menu for the printers which support Object Push Profile. If the file size is the more than each of 500KB(Animated GIF file) 200KB(others), the popup message is displayed "Not supported".

SIM SERVICE (Menu 5)

This menu depends on SIM and the network services.

- In case the SIM card support SAT(i.e. SIM Application Toolkit) services, this menu will be the operator specific service name stored on the SIM card.
- In case the SIM card does not support SAT services, this menu will be Profiles.

ACCESSORIES

There are various accessories for your mobile phone. You can select these options according to your personal communication requirements.

Travel Adapter

This charger allows you to charge the battery while away from home or your office.



Standard Battery



Data cable/CD

You can connect your phone to PC to exchange the data between them.



Hands free ear-microphone and music player controller combo

Stereo headset

Controller: Answer & End button, music player control, volume control, Hold button and microphone.



LCD cleaner



Leather case



Memory card



NETWORK SERVICE

The wireless phone described in this guide is approved for use on the GSM 900, DCS 1800, PCS1900 network.

- Dualband is a network dependent feature. Check with your local service provider if you can subscribe to and use this feature.
- A number of features included in this guide are called Network Services. These are special services that you arrange through your wireless service provider. Before you can take advantage of any of these Network Services, you must subscribe to them through your service provider and obtain instructions for their use from your service provider.

TROUBLESHOOTING

This chapter lists some problems that you might encounter while using your phone. Some problems require that you call your service provider, but most of problems you encounter are easy to correct yourself.

MESSAGE	POSSIBLE CAUSES	POSSIBLE CORRECTIVE MEASURES
SIM error	There is no SIM card in the phone or you may have inserted it incorrectly.	Make sure that the SIM card is correctly inserted.
No connection to the network	Signal weak Outside GSM network	Move higher to a window or open space. Check service provider coverage map.
Codes do not match	When you want to change a security code you have to confirm the new code by entering it again. The two codes that you have entered do not match.	Contact your Service Provider.
Function cannot be set	Not supported by Service Provider or registration required	Contact your Service Provider.
Calls not available	Dialling error New SIM card inserted Charge limit reached	New network not authorised. Check for new restrictions. Contact Service Provider or reset limit with PIN 2.
Phone cannot be switched on	On/Off key pressed too briefly Battery empty Battery contacts dirty	Press On/Off key for at least two seconds. Charge battery. Check charging indicator in the display. Clean contacts.

MESSAGE	POSSIBLE CAUSES	POSSIBLE CORRECTIVE MEASURES
Charging error	Battery totally empty	Charge battery.
	Temperature out of range	Make sure the ambient temperature is right, wait for a while, and then charge again.
	Contact problem	Check power supply and connection to the phone. Check the battery contacts, clean them if necessary.
	No mains voltage	Plug in to a different socket or check voltage.
	Charger defective	If the charger does not warm up, replace it.
	Wrong charger	Only use original LG accessories.
	Battery defective	Replace battery.
Phone loses network	Signal too weak	Reconnection to another service provider is automatic.
Number not permitted	The Fixed dial number function is on.	Check settings.

TECHNICAL DATA

General

Product name : KE850

System : GSM 900 / DCS 1800 / PCS 1900

Ambient Temperatures

Max. : +55°C (discharging)

+45°C (charging)

Min : -10°C

Declaration of Conformity



LG Electronics

Supplier Details

Name

LG Electronics Inc

Address

: LG Twin Tower 20, Yeuido-dong, Yeoungpo-gu Seoul Korea 150-721

Product Details

Product Name

E-GSM 900 / DCS 1800 / PCS 1900 / Tri Band Terminal Equipment

Model Name

KE850

Trade Name

LG

CE 0168

Applicable Standards Details

RATTE Directive 1999/5/EC

EN 301 489-01 v1.6.1 / EN 301 489-07 v1.3.1 / EN 301 489-17 v1.2.1
EN 300 328 V 1.6.1
EN 60954-1 : 2001
EN 50309/VEN 50361 : 2001
EN 301 511 V9.0.2

Supplementary Information

The conformity to above standards is verified by BABT.

Declaration

I hereby declare under our sole responsibility that the product mentioned above to which this declaration relates complies with the above mentioned standards and Directives

Name

Issued Date

Jin Seog, Kim / Director

11, September, 2006

LG Electronics Logistics and Services B.V.
Veluwezoom 15, 1327 AE Almere, The Netherlands
Tel: +31 - 36-547 - 8640, e-mail : seockim @ lge.com

Signature of representative

LIMITED WARRANTY STATEMENT

1. WHAT THIS WARRANTY COVERS :

LG offers you a limited warranty that the enclosed phone and its enclosed accessories will be free from defects in material and workmanship according to the following terms and conditions:

- (1) The limited warranty for the product extends the warranty period beginning on the date of purchase of the product.
- (2) The limited warranty applies for 1 year from the original date of purchase and extends only to the original purchaser of the product and is not assignable or transferable to any subsequent purchaser/end user. It shall neither exclude nor limit any mandatory statutory rights of the customer or any of the customer rights against the seller/dealer of the product.
- (3) This warranty is good only to the original purchaser during the warranty period, but limited to certain country if specified.
- (4) The external housing and cosmetics parts shall be free of defects at the time of shipment and, therefore, shall not be covered under these limited warranty terms.
- (5) Upon request from LG. or their designated service agent the consumer must provide information to reasonably prove the date of purchase.
- (6) Unless other service arrangements have been specified the customer shall bear the cost of shipping a defective product back to the Customer Service Department of LG. LG shall bear the cost of shipping the product back to the consumer after the completion of service under this limited warranty.
- (7) During the warranty period LG or its authorised service agent will repair or replace at LG's sole discretion a defective product. A repaired or replaced product will not be given a prolonged or renewed warranty period.

Additionally, you can call our Customer Services Helpline on 08700 505123 for any phone related technical queries.

2. WHAT THIS WARRANTY DOES NOT COVER :

- (1) Defects OR Damages resulting from use of the product in other than its normal and customary manner.
- (2) Defects or damages from abnormal use, abnormal conditions, improper storage, exposure to moisture or dampness, unauthorised modifications, unauthorised connections, unauthorised repair, neglect, abuse, accident, alteration, improper

installation, or other acts which are not the fault of LG, including damage caused by shipping, blown fuses, spills of food or liquid.

- (3) Breakage or damage to antennas unless caused directly by defects in material or workmanship.
- (4) A warranty repair if the Customer Service Department at LG or other agreed service agent was not notified by the consumer of the alleged defect or malfunction of the product during the applicable limited warranty period.
- (5) Products which have had the serial number or IMEI number removed or made illegible.
- (6) This limited warranty is in lieu of all other warranties, express or implied either in fact or by operations of law, statutory or otherwise, including, but not limited to any implied warranty of marketability or fitness for a particular use.
- (7) Damage resulting from use of non-LG approved accessories.
- (8) All plastic surfaces and all other externally exposed parts that are scratched or damaged due to normal customer use.
- (9) Products operated outside published maximum ratings.
- (10) Products used or obtained in a rental program.
- (11) Consumables (such as fuses).
- (12) Suspected defects caused by a failure of the cellular network.

3. CONDITIONS :

No other express warranty is applicable to this product.

THE DURATION OF ANY IMPLIED WARRANTIES, INCLUDING THE IMPLIED WARRANTY OF MARKETABILITY, IS LIMITED TO THE DURATION OF THE EXPRESS WARRANTY HEREIN. LG ELECTRONICS INC. SHALL NOT BE LIABLE FOR THE LOSS OF THE USE OF THE PRODUCT, INCONVENIENCE, LOSS OR ANY OTHER DAMAGES, DIRECT OR CONSEQUENTIAL, ARISING OUT OF THE USE OF, OR INABILITY TO USE, THIS PRODUCT OR FOR ANY EXPRESS OR IMPLIED WARRANTY, INCLUDING THE IMPLIED MARKETABILITY APPLICABLE TO THIS PRODUCT.

Some do not allow the exclusive of limitation of incidental or consequential damages or limitations on how long an implied warranty lasts; so these limitations or exclusions may not apply to you. This warranty gives you specific legal rights and you may also have other rights which vary from country to country.



LG Electronics Inc.